

C_830x650

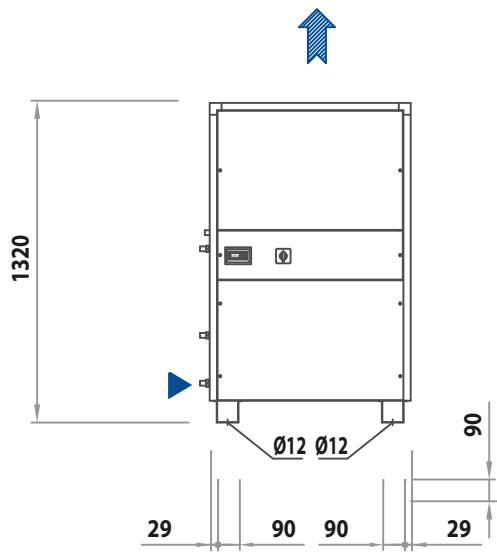

FRONT VIEW

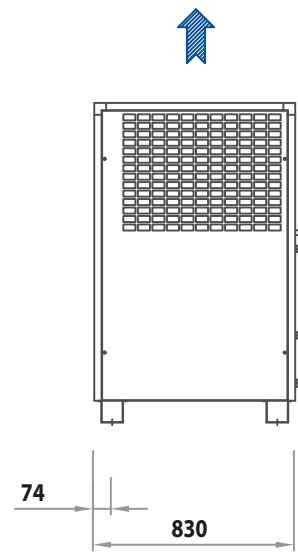

BACK VIEW

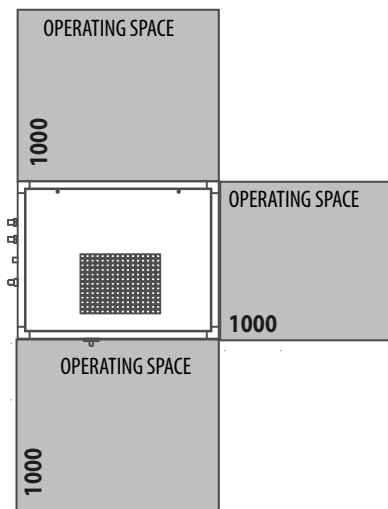

TOP VIEW

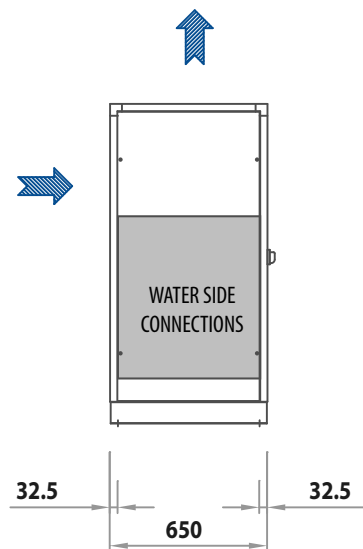

SIDE VIEW

-  CONDENSER AIR FLOW
-  ELECTRIC CABLES INPUT

C_980x800

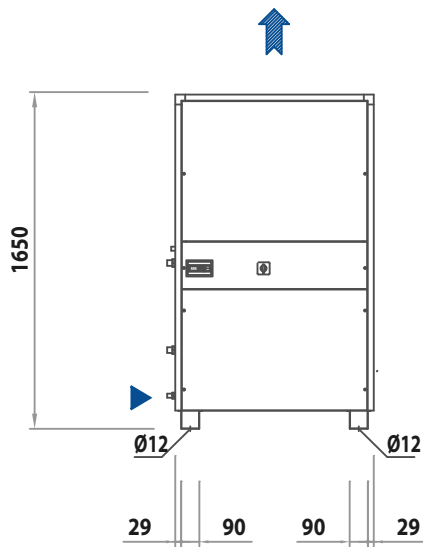

FRONT VIEW

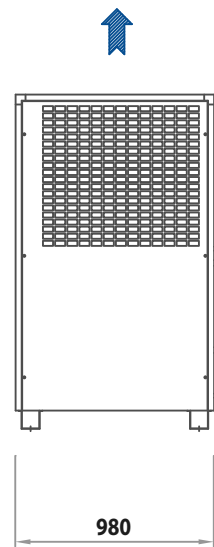

BACK VIEW

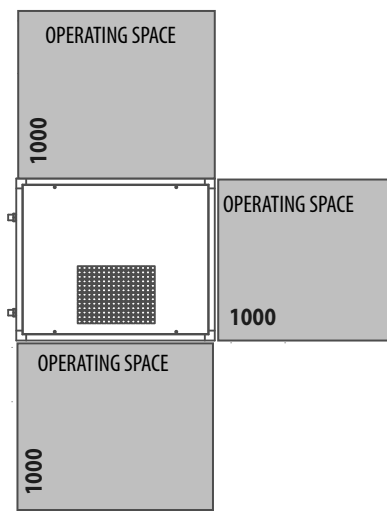

TOP VIEW

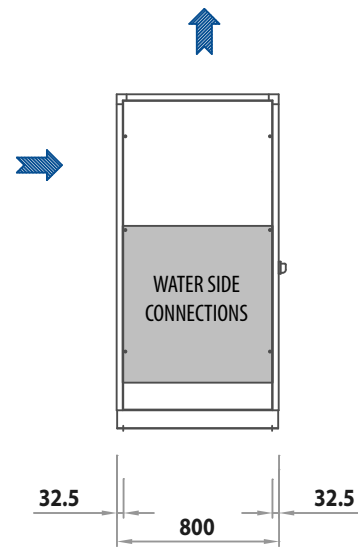

SIDE VIEW



CONDENSER AIR FLOW



ELECTRIC CABLES INPUT

C_1280x990

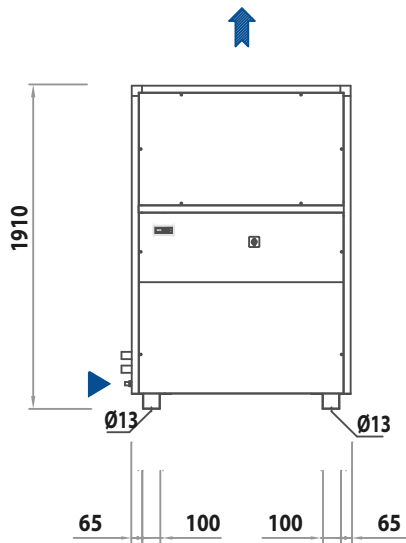

FRONT VIEW

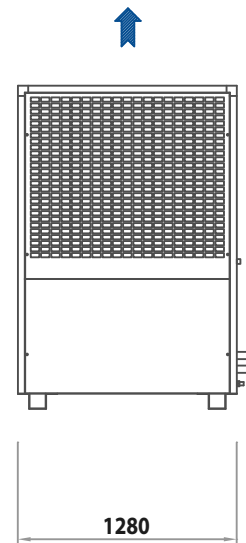

BACK VIEW

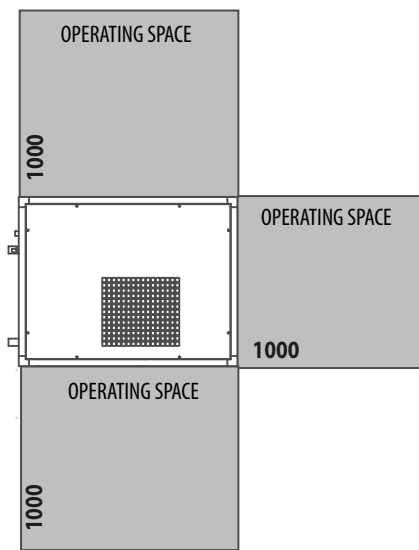

TOP VIEW

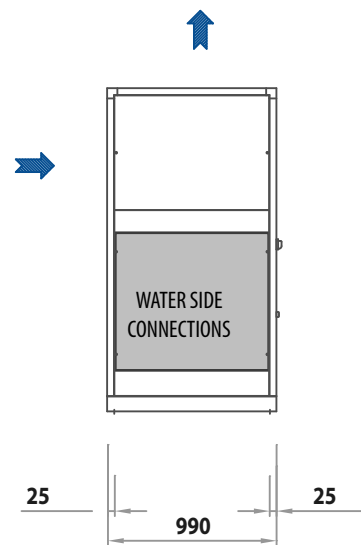

SIDE VIEW

↑ CONDENSER AIR FLOW

▶ ELECTRIC CABLES INPUT

C_1930x990

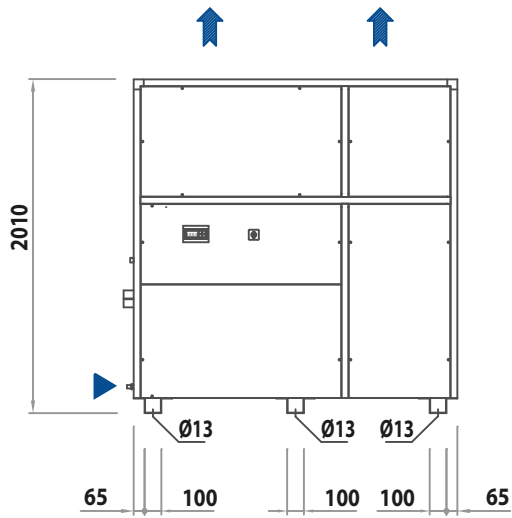

FRONT VIEW

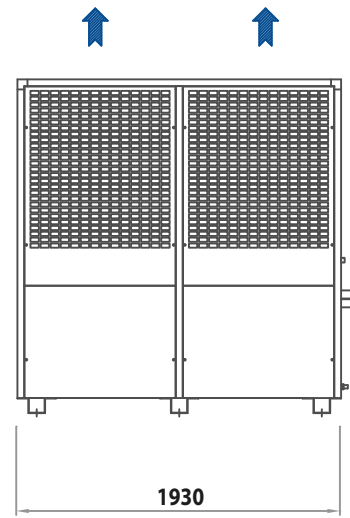

BACK VIEW

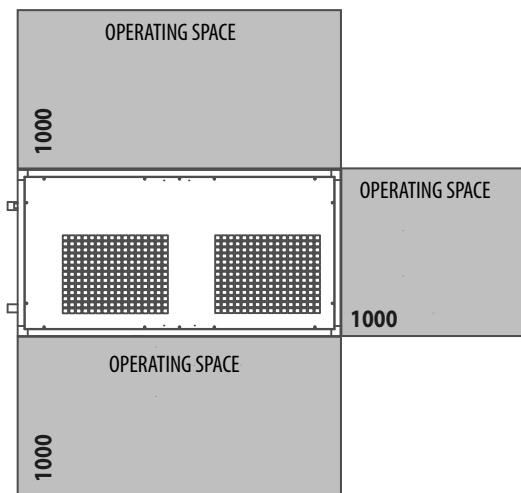

TOP VIEW

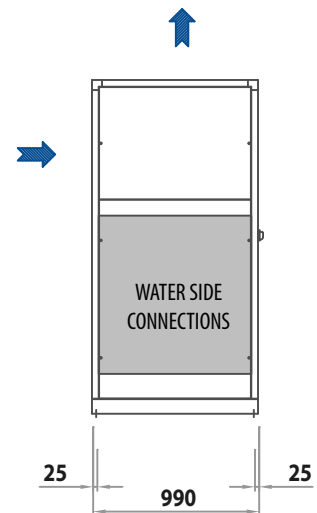

SIDE VIEW

-  CONDENSER AIR FLOW
-  ELECTRIC CABLES INPUT