

# W\_830x650

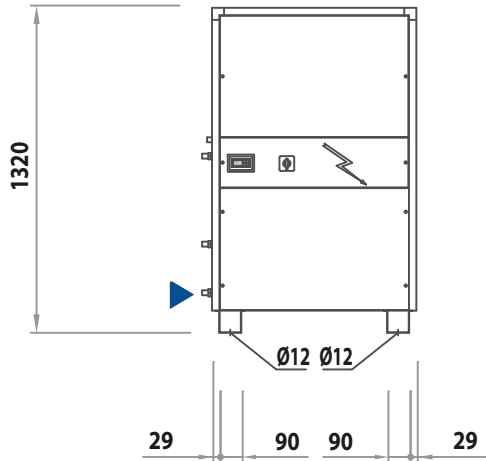

**FRONT VIEW**

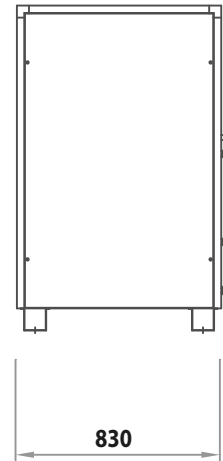

**BACK VIEW**

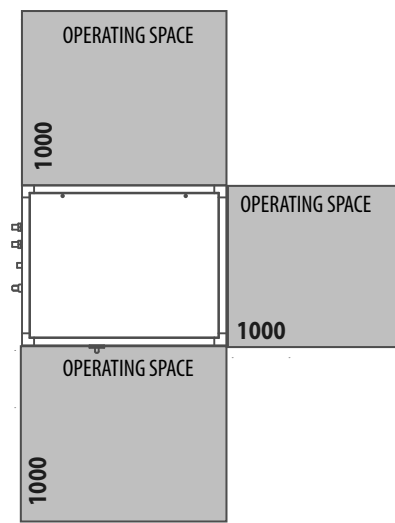

**TOP VIEW**

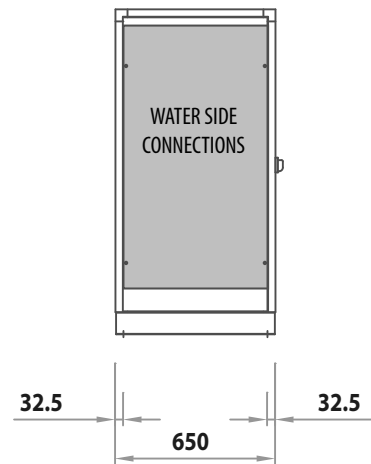

**SIDE VIEW**

▶ **ELECTRIC CABLES INPUT**

# W\_830x650r

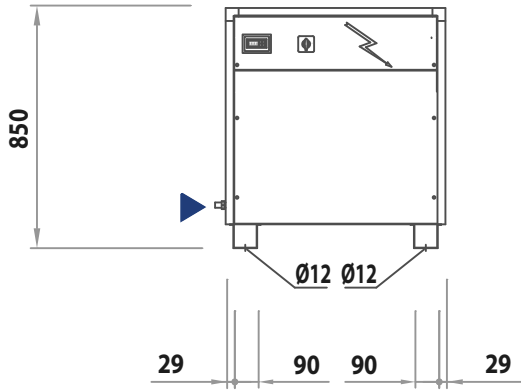

**FRONT VIEW**

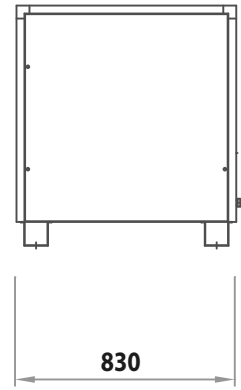

**BACK VIEW**

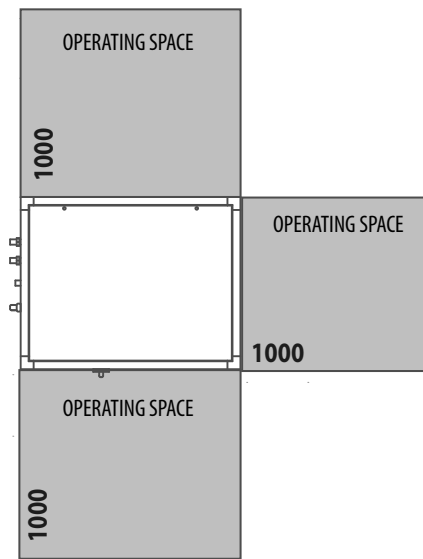

**TOP VIEW**

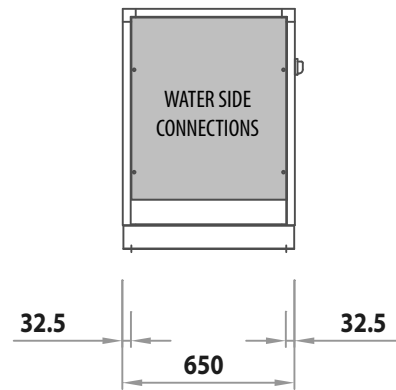

**SIDE VIEW**

► **ELECTRIC CABLES INPUT**

# W\_980x800

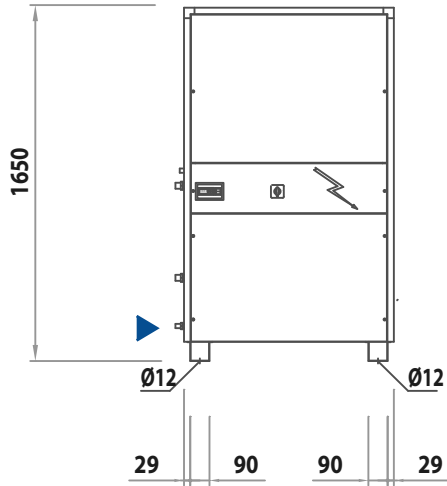

**FRONT VIEW**

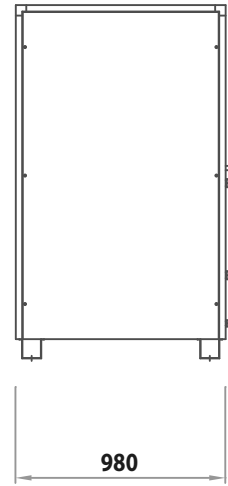

**BACK VIEW**

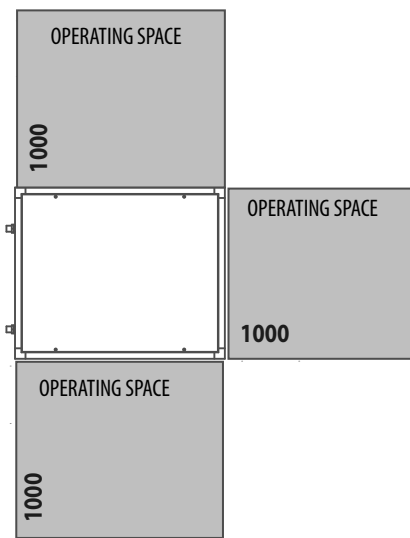

**TOP VIEW**

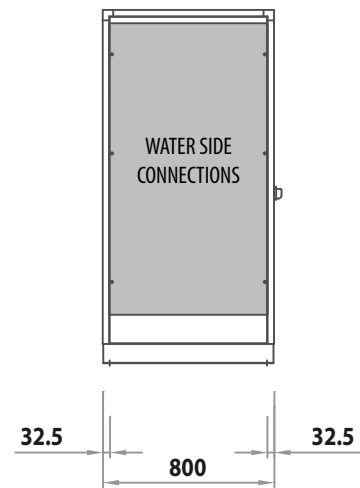

**SIDE VIEW**

► **ELECTRIC CABLES INPUT**

# W\_980x800r

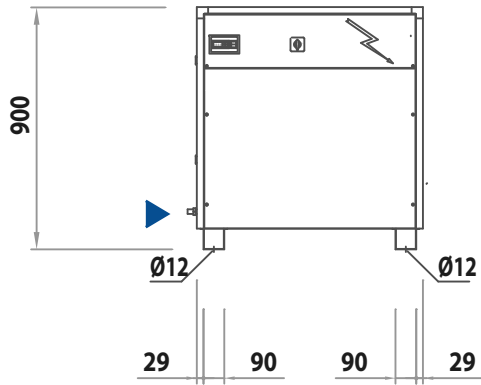

**FRONT VIEW**

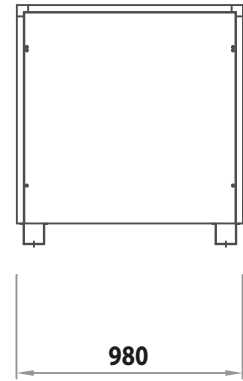

**BACK VIEW**

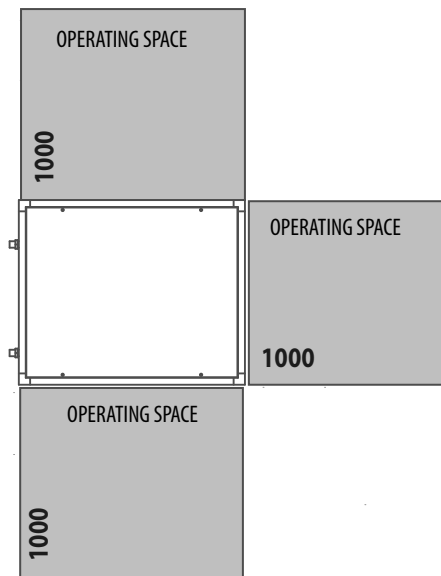

**TOP VIEW**

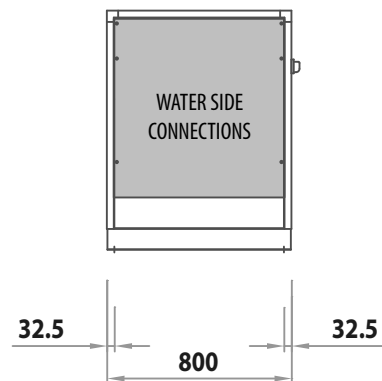

**SIDE VIEW**

▶ **ELECTRIC CABLES INPUT**

# W\_1930x990

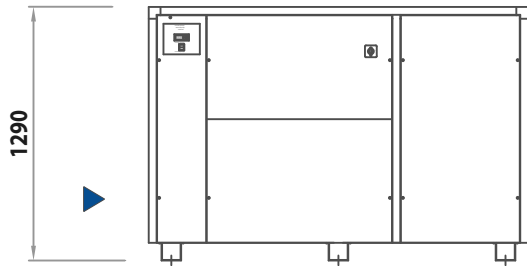

**FRONT VIEW**

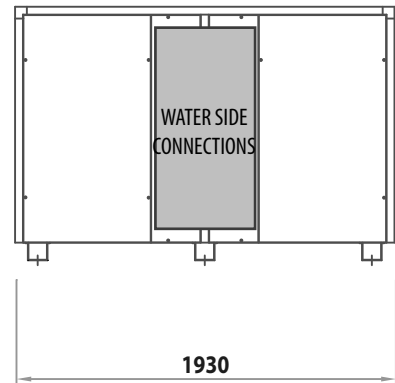

**BACK VIEW**

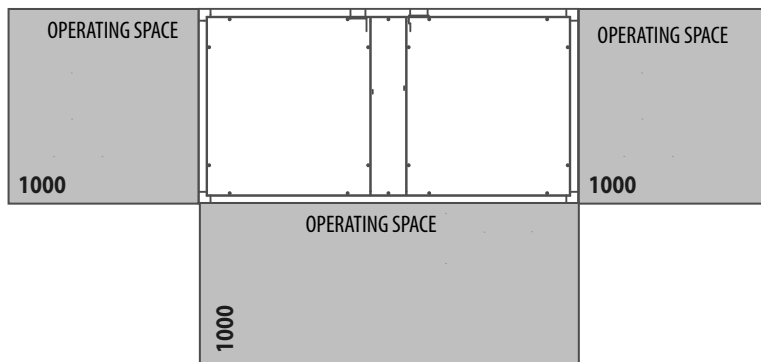

**TOP VIEW**

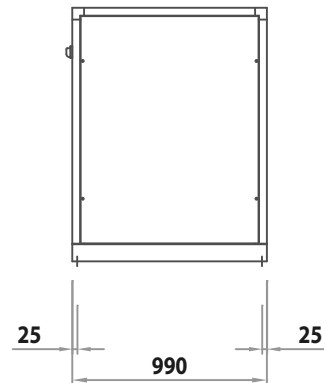

**SIDE VIEW**

▶ **ELECTRIC CABLES INPUT**

# W\_2580x990

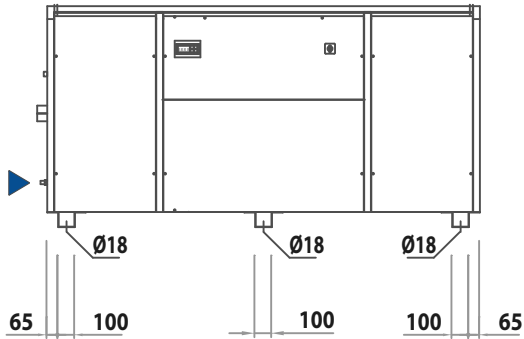

**FRONT VIEW**

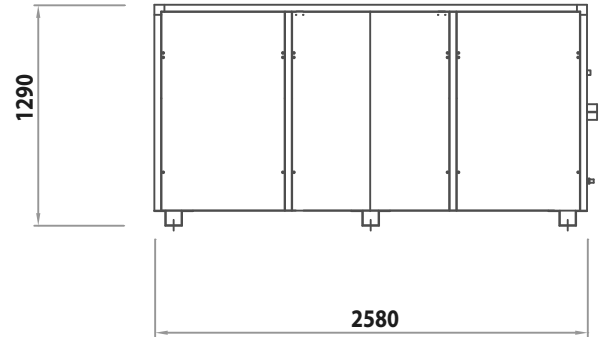

**BACK VIEW**

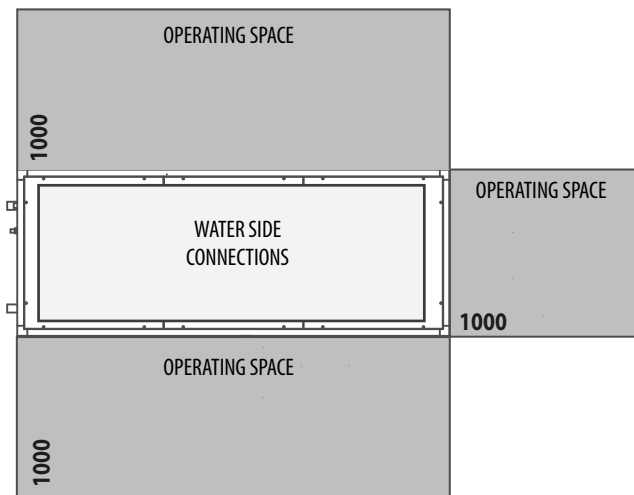

**TOP VIEW**

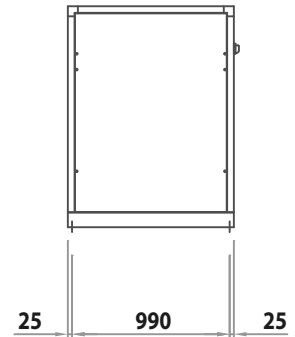

**SIDE VIEW**

► **ELECTRIC CABLES INPUT**

# W\_3520x990r

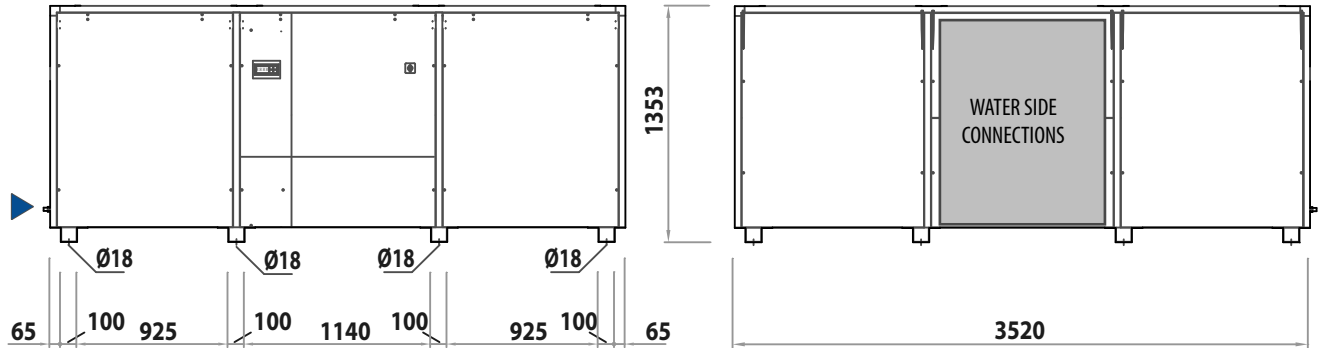

**FRONT VIEW**

**BACK VIEW**

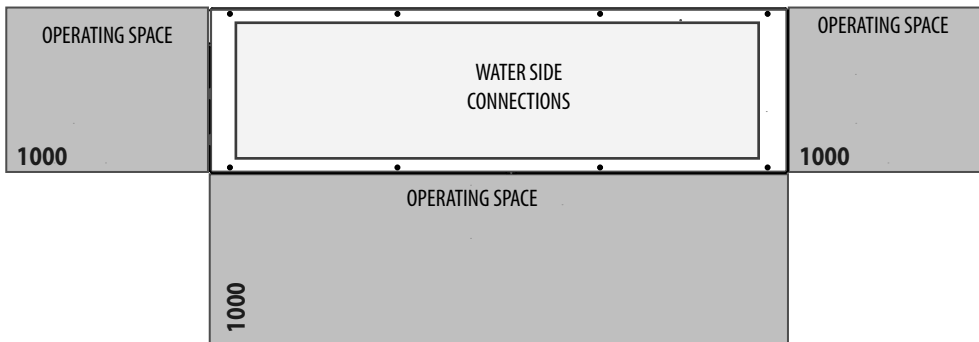

**TOP VIEW**

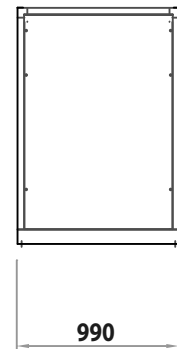

**SIDE VIEW**

▶ **ELECTRIC CABLES INPUT**