

A_830x650

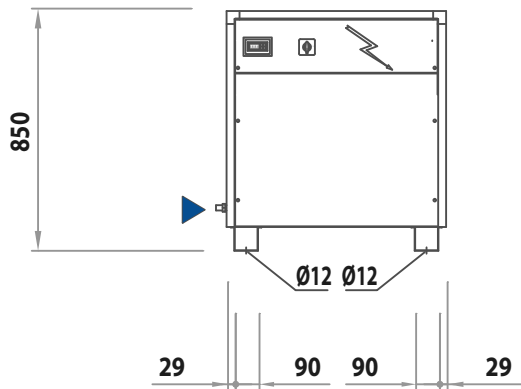

FRONT VIEW

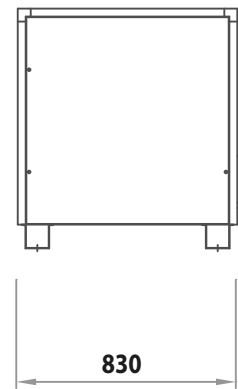

BACK VIEW

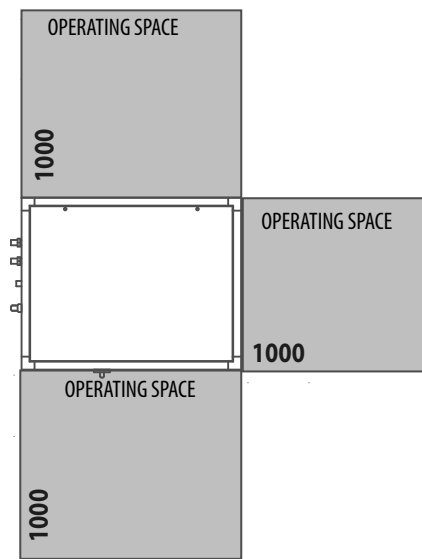

TOP VIEW

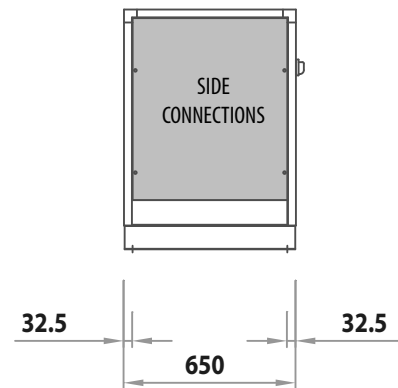

SIDE VIEW

▶ **ELECTRIC CABLES INPUT**

A_980x800

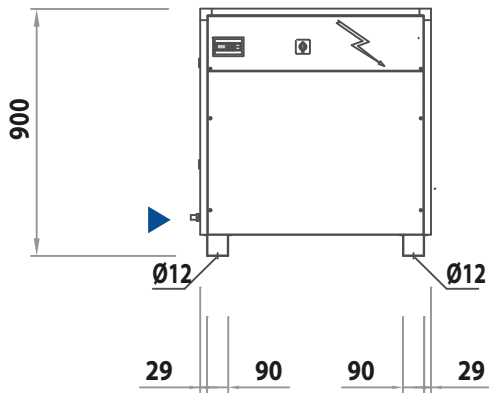

FRONT VIEW

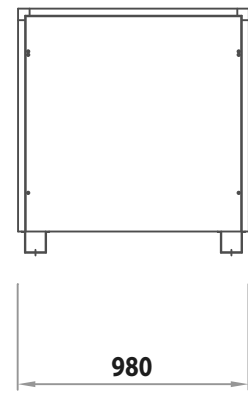

BACK VIEW

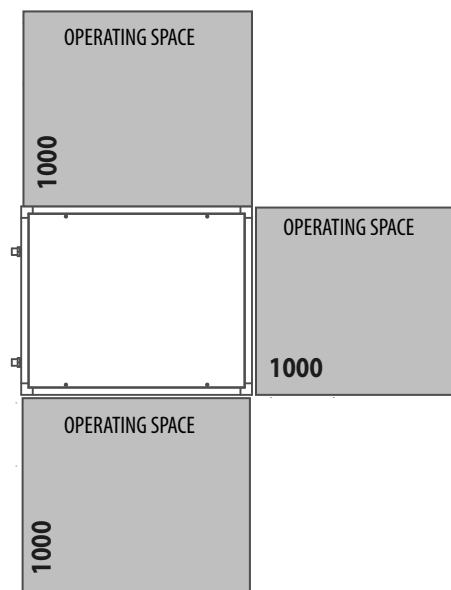

TOP VIEW

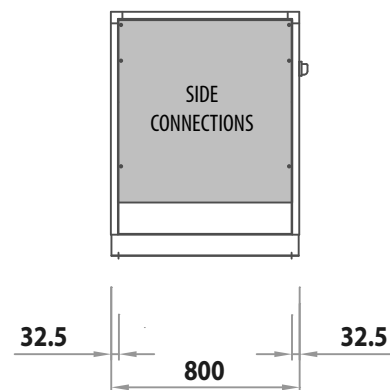

SIDE VIEW

► **ELECTRIC CABLES INPUT**

A_1 000x650

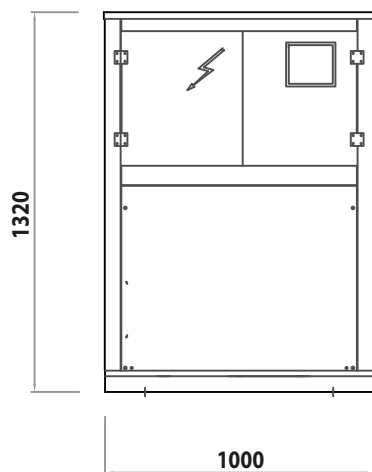

FRONT VIEW

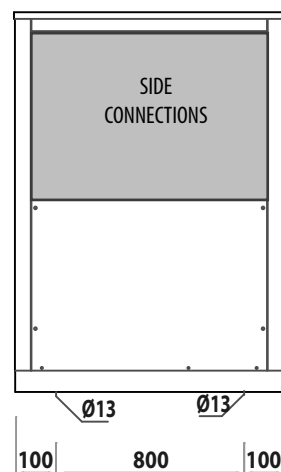

BACK VIEW

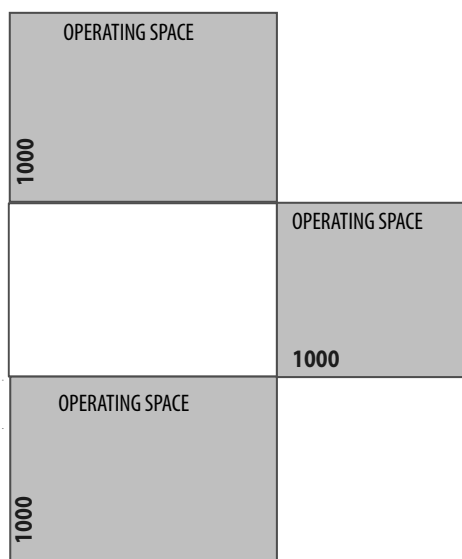

TOP VIEW

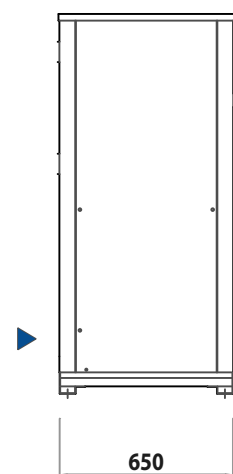

SIDE VIEW

► ELECTRIC CABLES INPUT

A_1 280x990

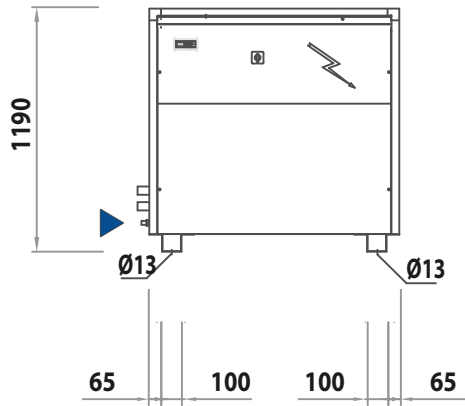

FRONT VIEW

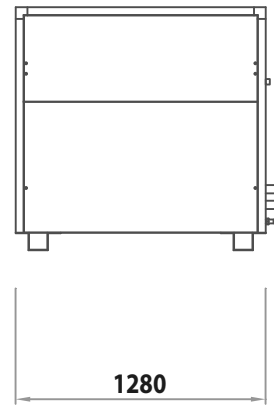

BACK VIEW

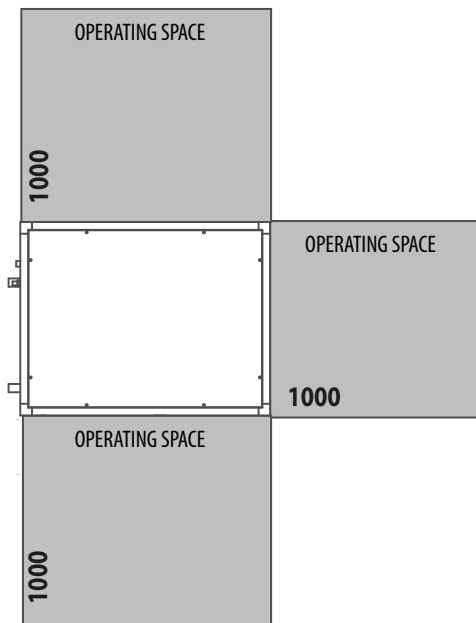

TOP VIEW

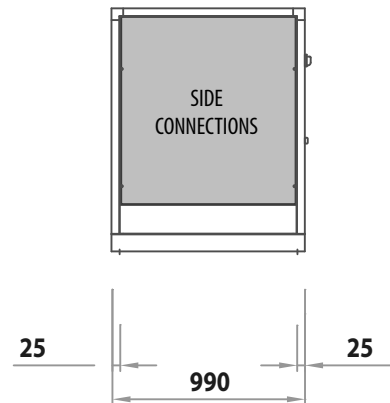

SIDE VIEW

► **ELECTRIC CABLES INPUT**

A_1 300x650

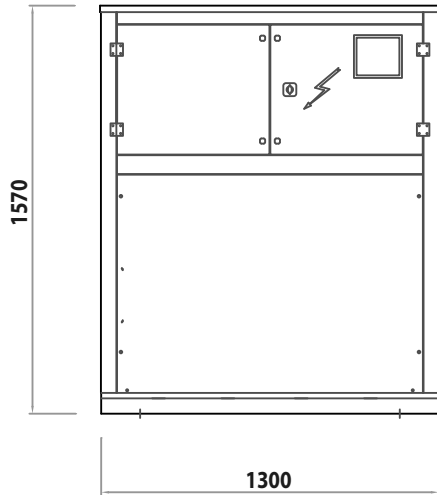

FRONT VIEW

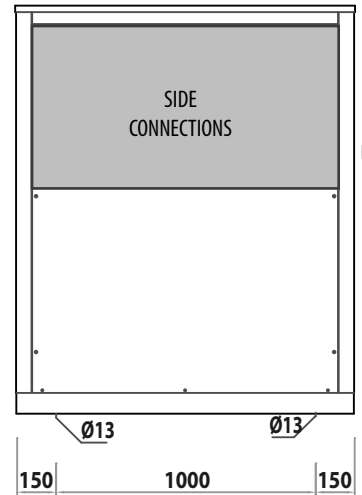

BACK VIEW

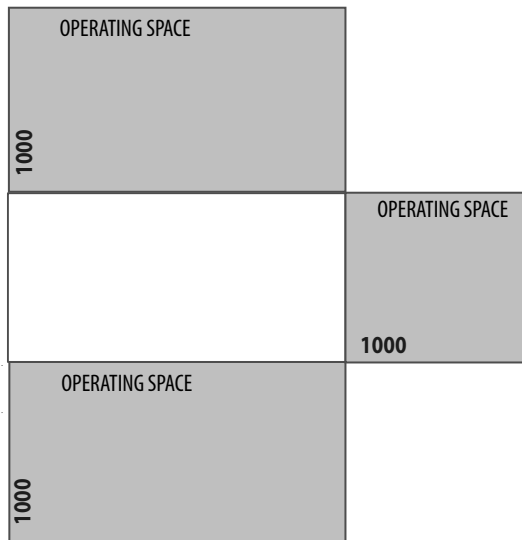

TOP VIEW

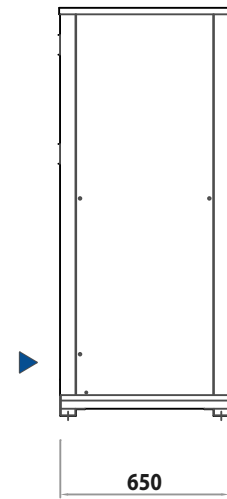

SIDE VIEW

▶ **ELECTRIC CABLES INPUT**

A_2250x820

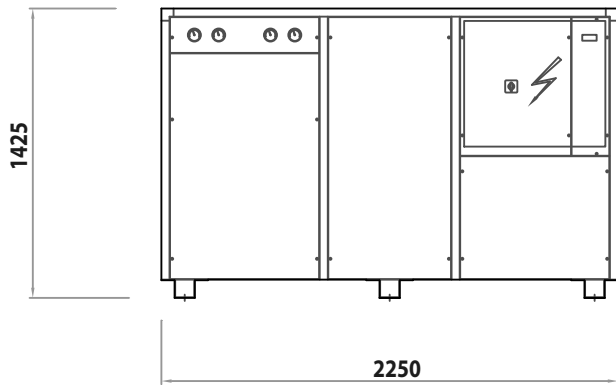

FRONT VIEW

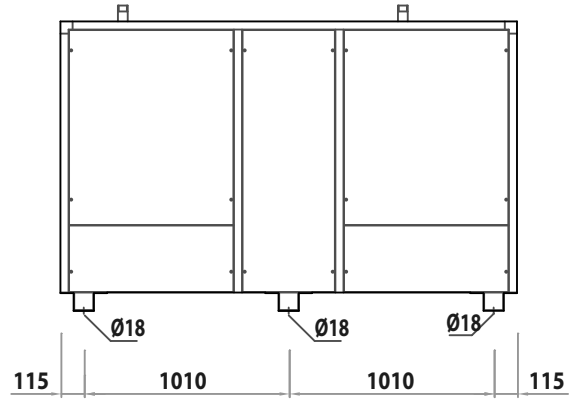

BACK VIEW

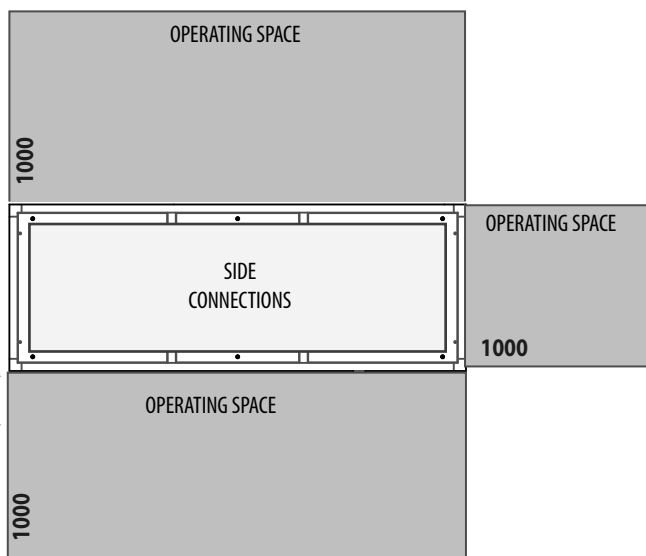

TOP VIEW

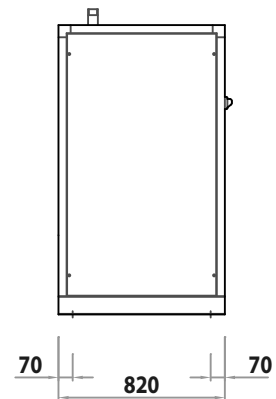

SIDE VIEW

▶ **ELECTRIC CABLES INPUT**

A_2580x990

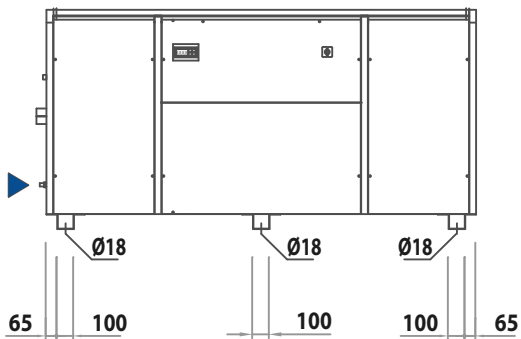

FRONT VIEW

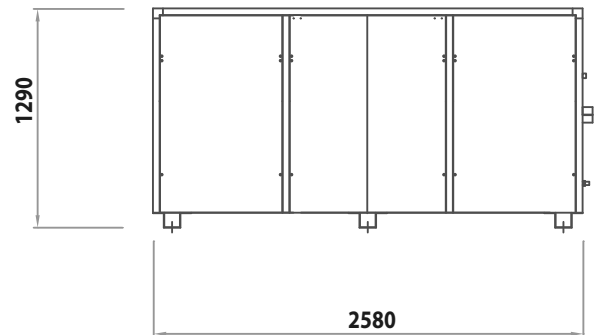

BACK VIEW

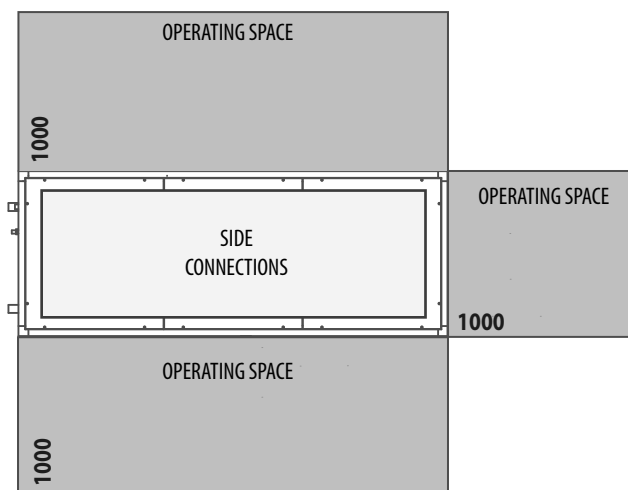

TOP VIEW

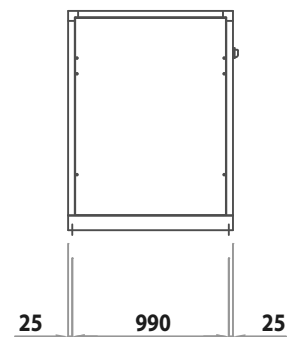

SIDE VIEW

▶ **ELECTRIC CABLES INPUT**

A_3520x990r

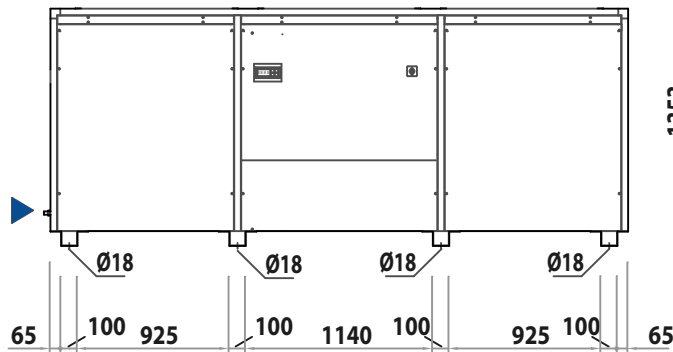

FRONT VIEW

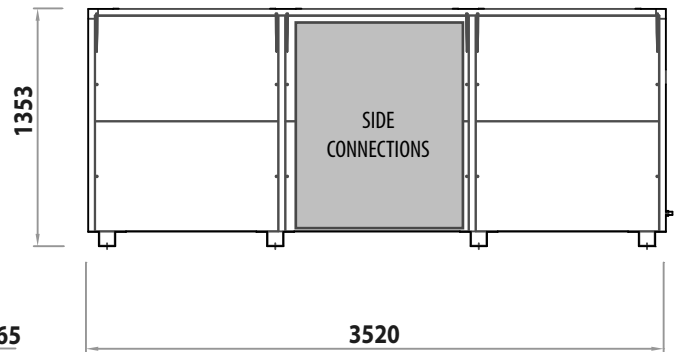

BACK VIEW

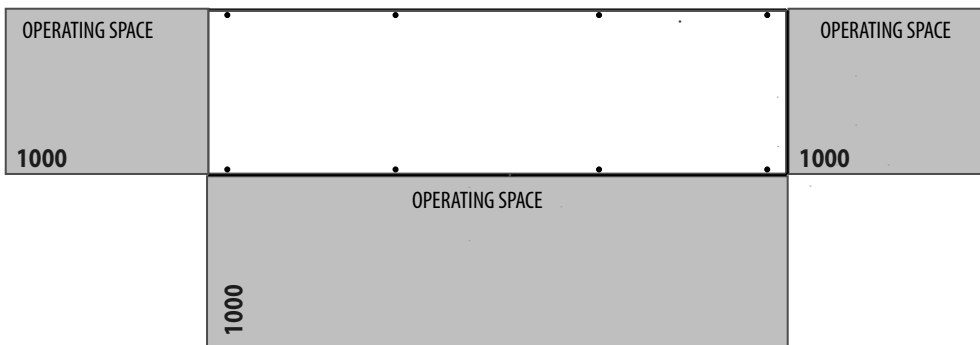

TOP VIEW

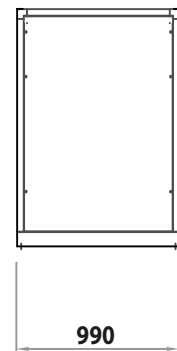

SIDE VIEW

▶ **ELECTRIC CABLES INPUT**