

C_830x650

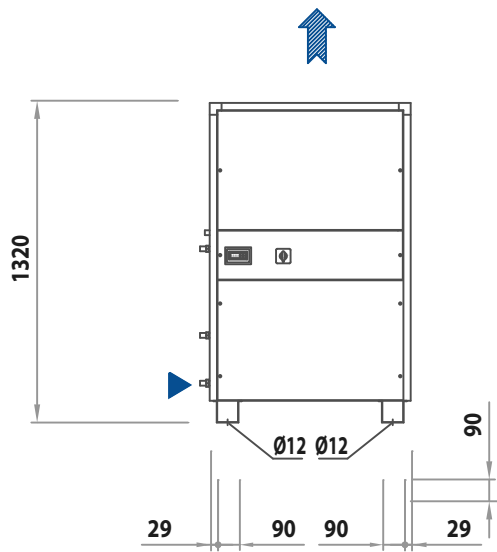

FRONT VIEW

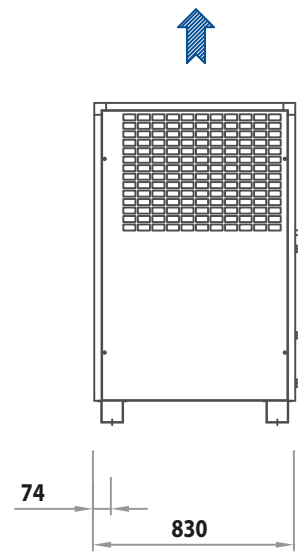

BACK VIEW

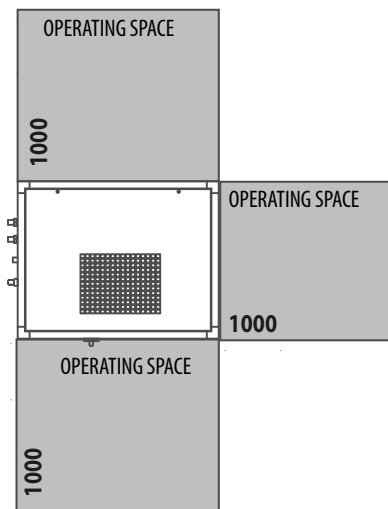

TOP VIEW

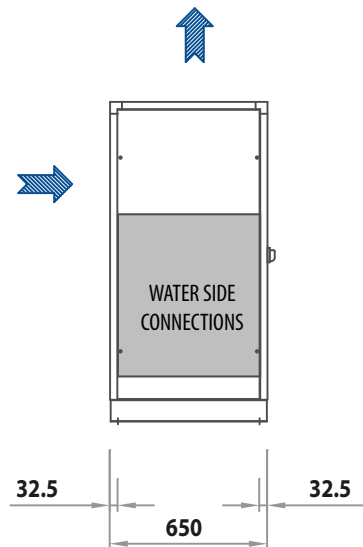

SIDE VIEW



CONDENSER AIR FLOW



ELECTRIC CABLES INPUT

C_980x800

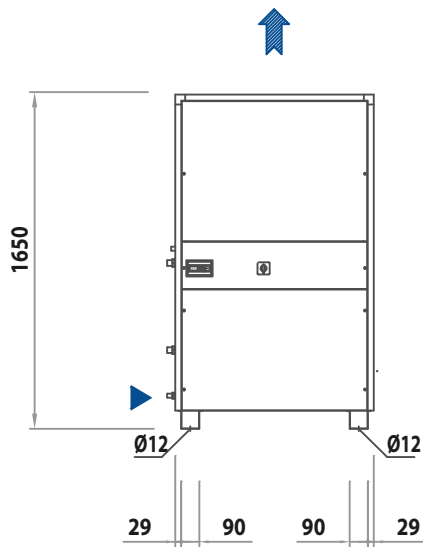

FRONT VIEW

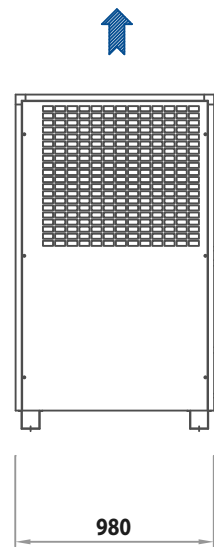

BACK VIEW

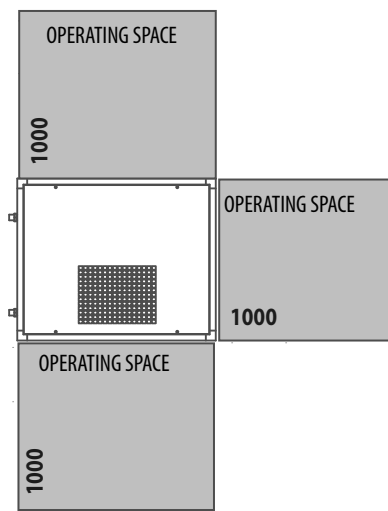

TOP VIEW

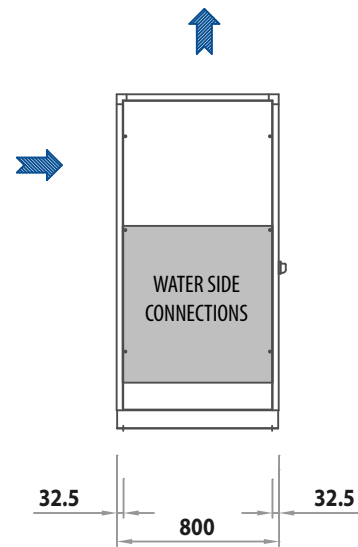

SIDE VIEW



CONDENSER AIR FLOW



ELECTRIC CABLES INPUT

C_1280x990

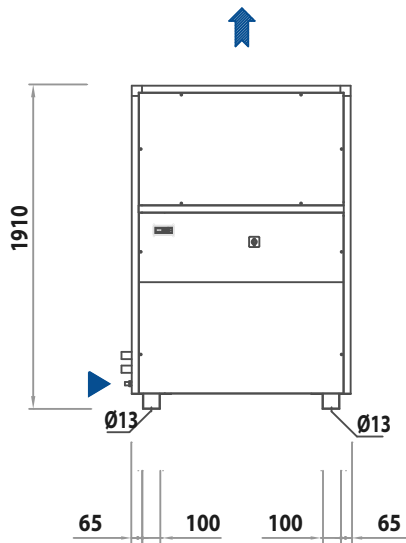

FRONT VIEW

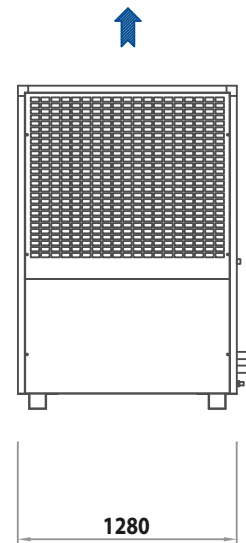

BACK VIEW

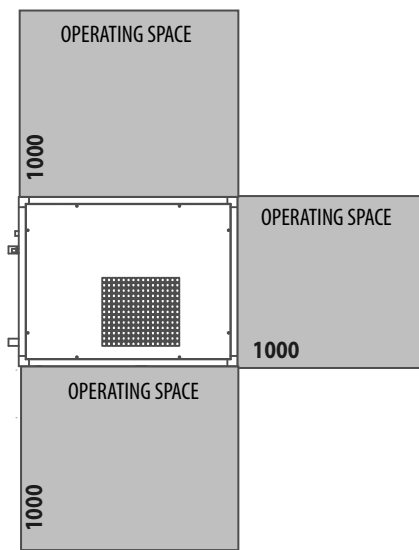

TOP VIEW

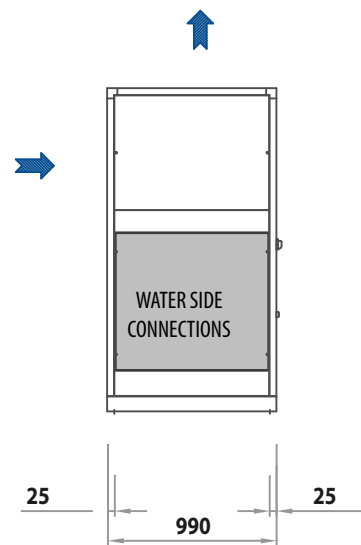

SIDE VIEW



CONDENSER AIR FLOW



ELECTRIC CABLES INPUT

C_1930x990

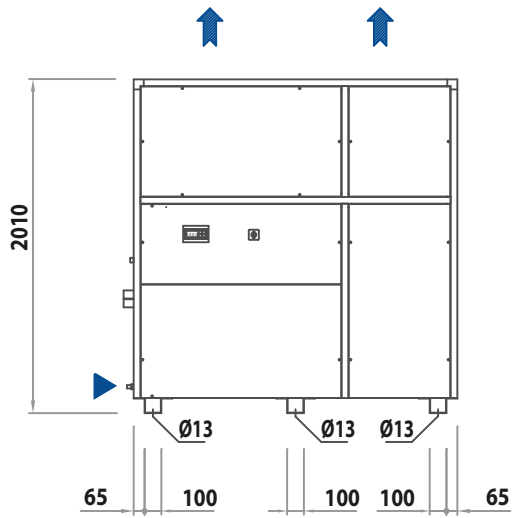

FRONT VIEW

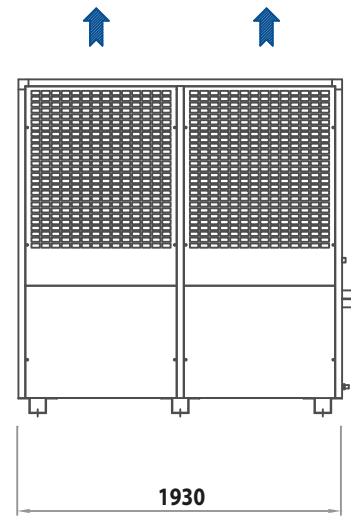

BACK VIEW

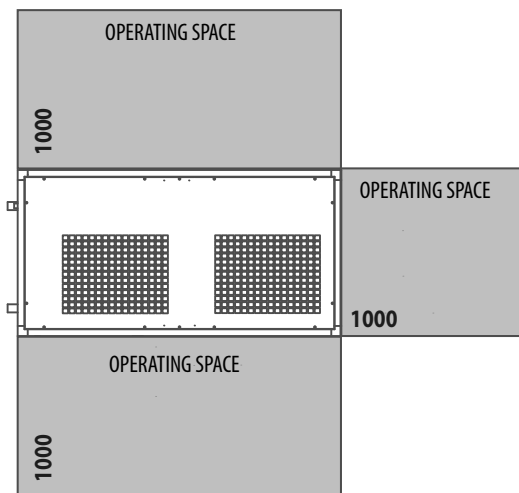

TOP VIEW

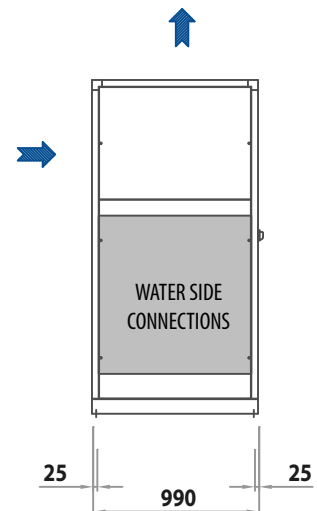

SIDE VIEW



CONDENSER AIR FLOW



ELECTRIC CABLES INPUT

C_2580x990

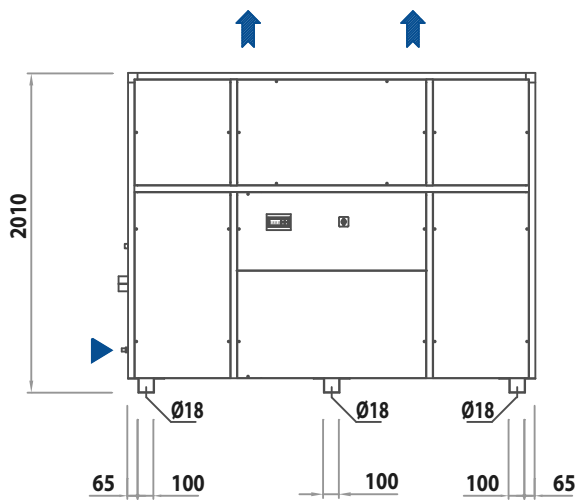

FRONT VIEW

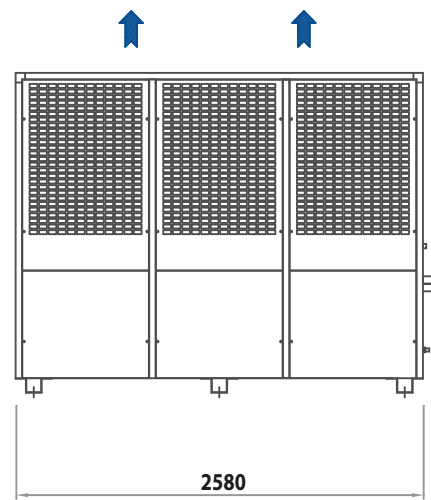

BACK VIEW

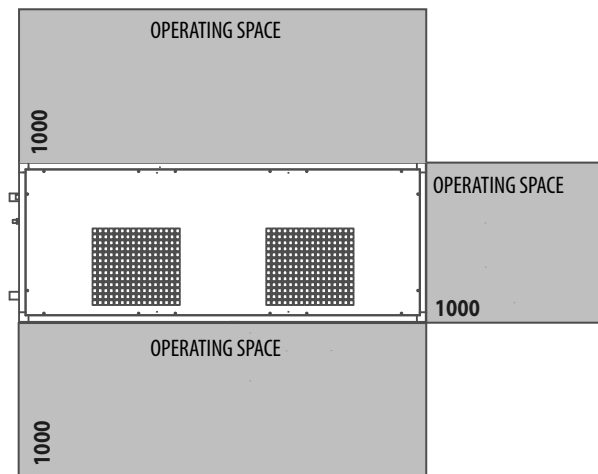

TOP VIEW

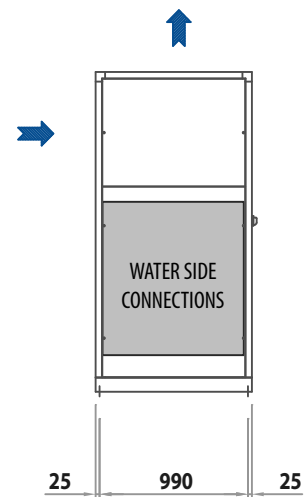

SIDE VIEW



CONDENSER AIR FLOW



ELECTRIC CABLES INPUT

C_3520x990

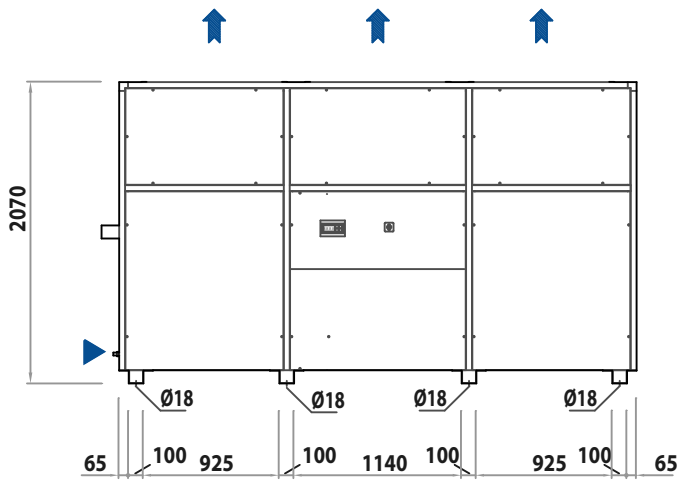

FRONT VIEW

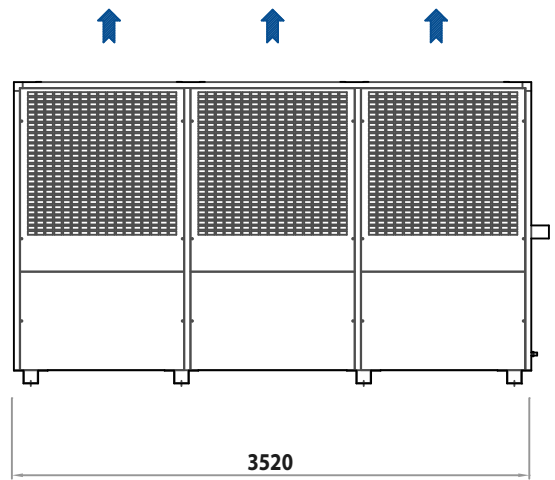

BACK VIEW

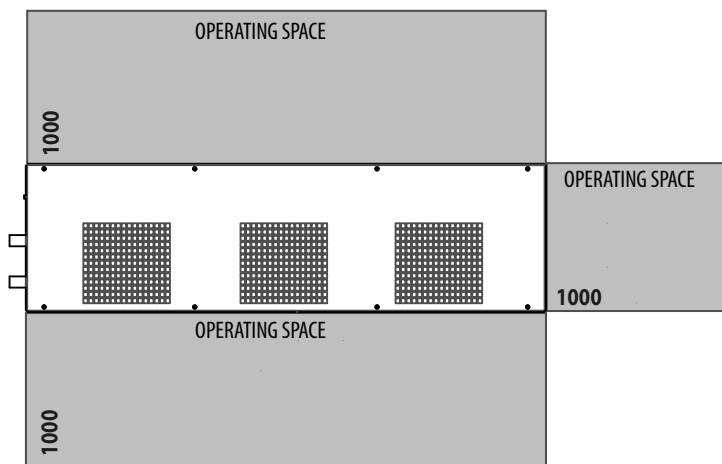

TOP VIEW

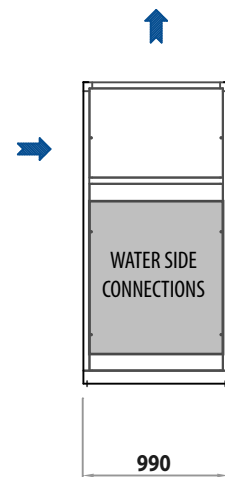

SIDE VIEW

↑ CONDENSER AIR FLOW

▶ ELECTRIC CABLES INPUT

C_4400x1150

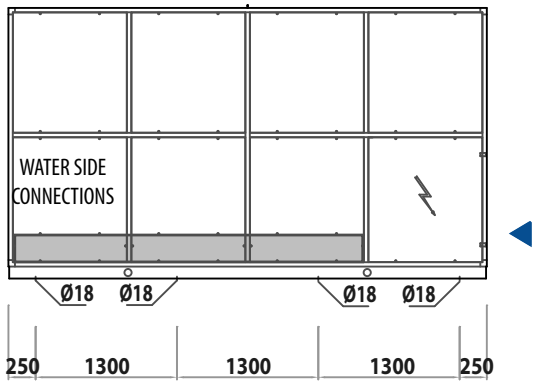

FRONT VIEW

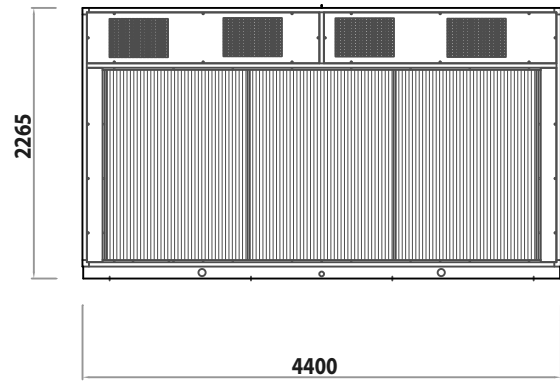

BACK VIEW

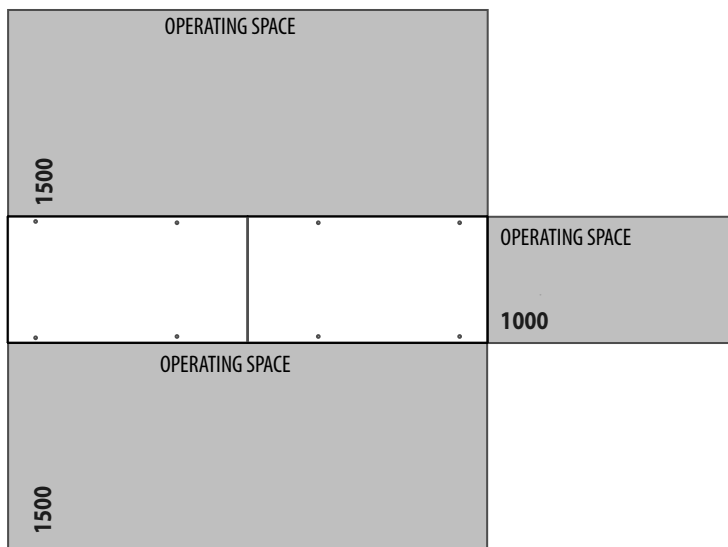

TOP VIEW

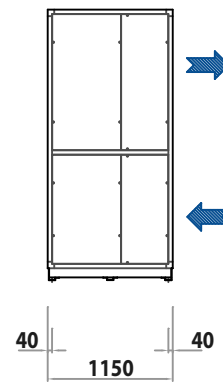

SIDE VIEW



CONDENSER AIR FLOW



ELECTRIC CABLES INPUT

C_5000x1500

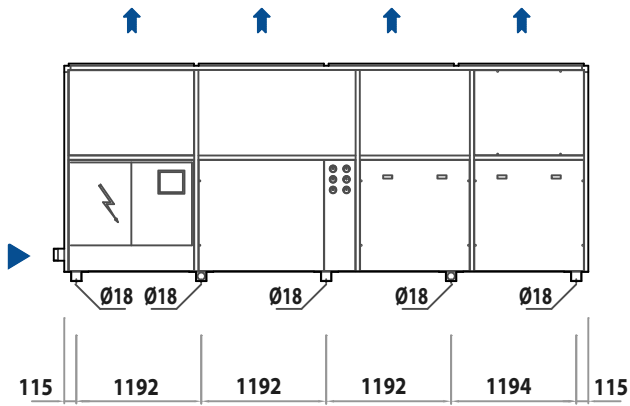

FRONT VIEW

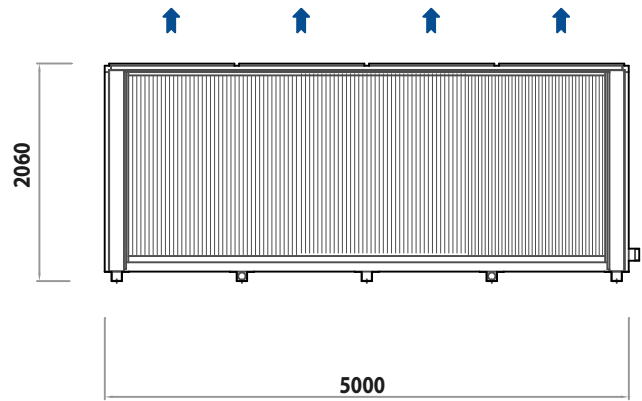

BACK VIEW

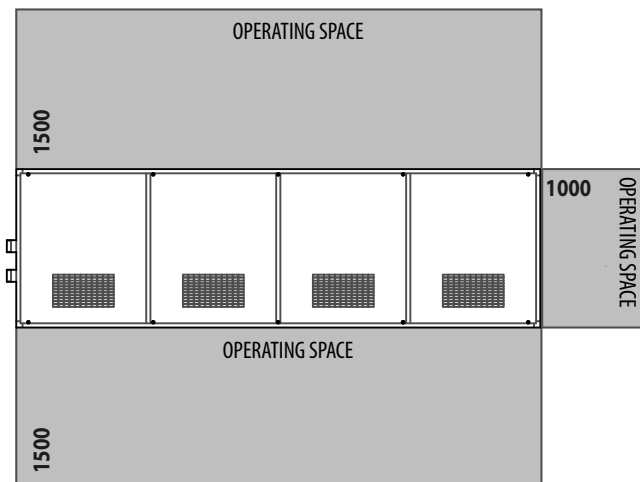

TOP VIEW

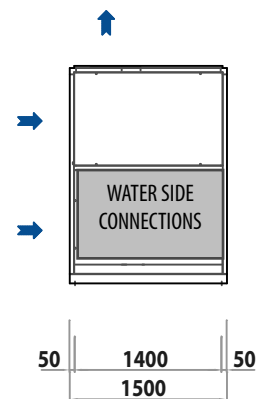

SIDE VIEW



CONDENSER AIR FLOW



ELECTRIC CABLES INPUT