

W_830x650

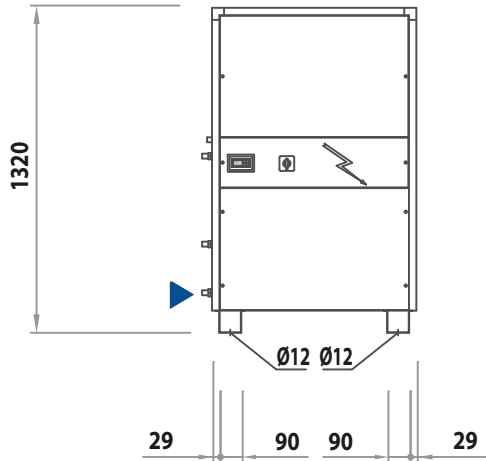

FRONT VIEW

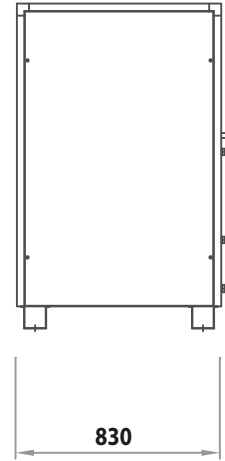

BACK VIEW

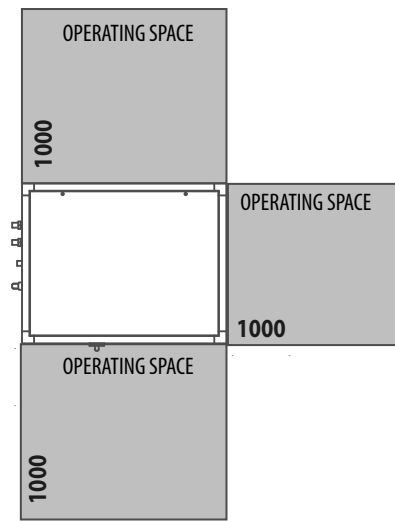

TOP VIEW

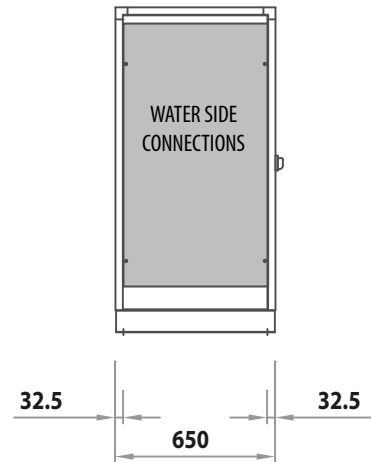

SIDE VIEW

▶ **ELECTRIC CABLES INPUT**

W_830x650r

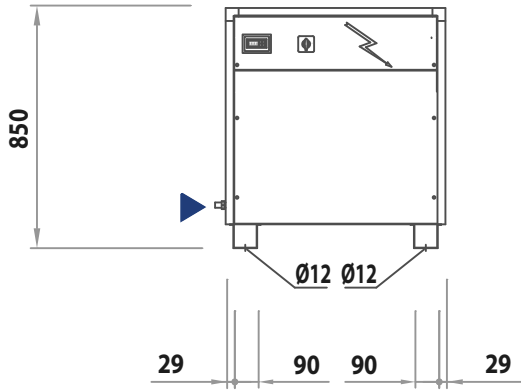

FRONT VIEW

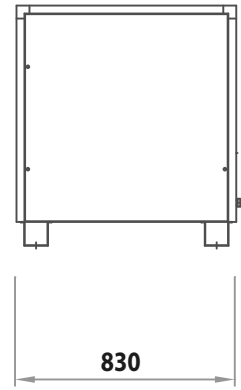

BACK VIEW

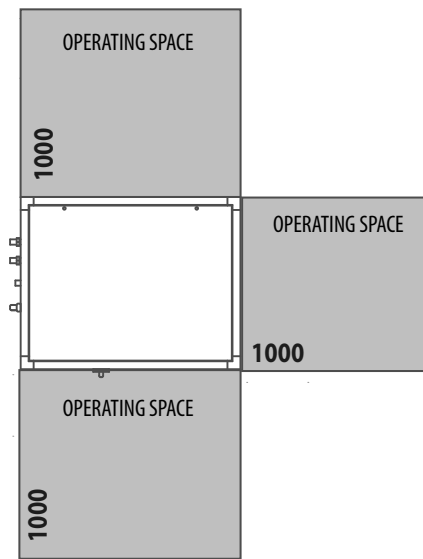

TOP VIEW

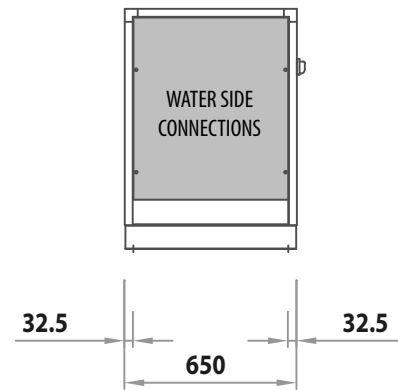

SIDE VIEW

► **ELECTRIC CABLES INPUT**

W_980x800

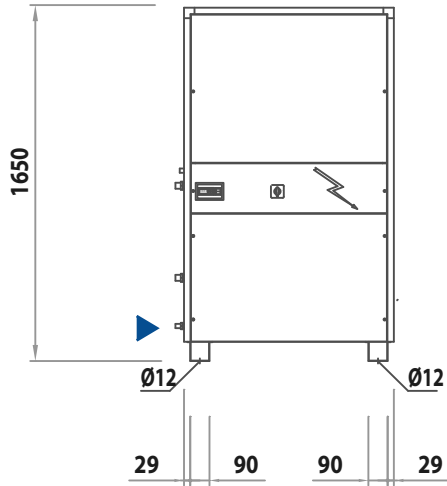

FRONT VIEW

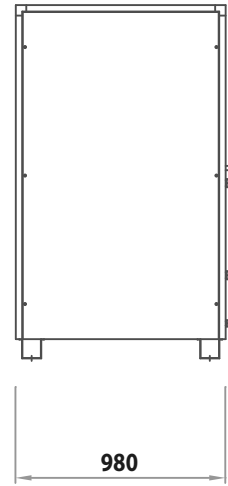

BACK VIEW

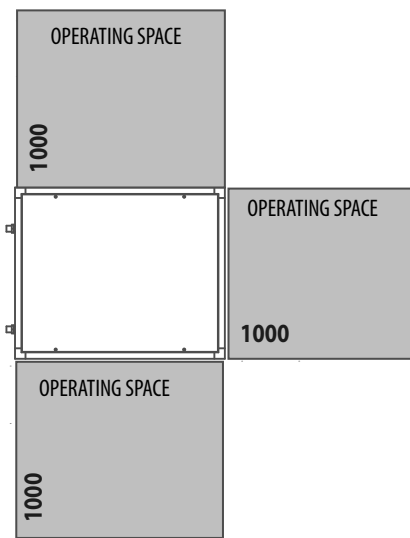

TOP VIEW

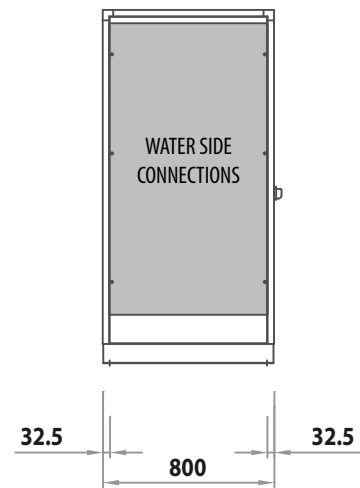

SIDE VIEW

► **ELECTRIC CABLES INPUT**

W_980x800r

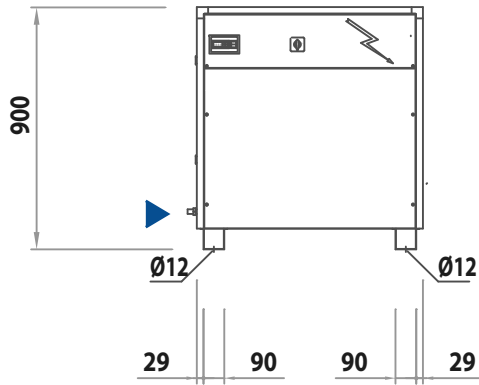

FRONT VIEW

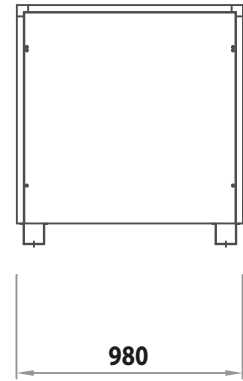

BACK VIEW

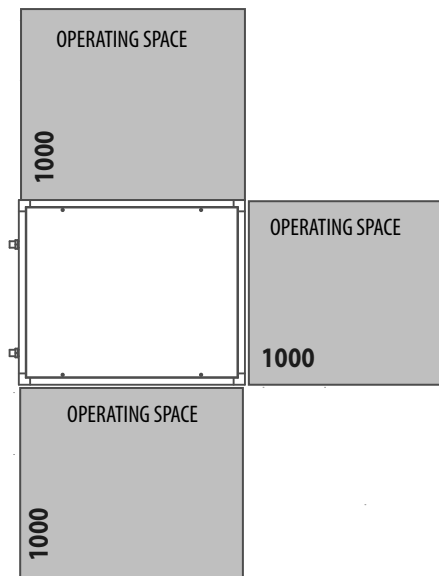

TOP VIEW

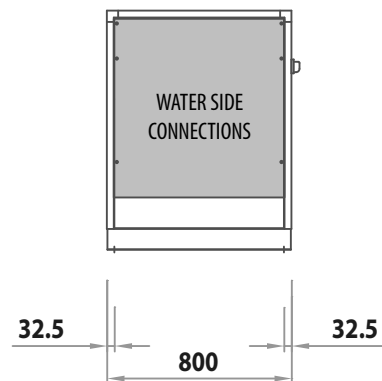

SIDE VIEW

▶ **ELECTRIC CABLES INPUT**

W_1000x650

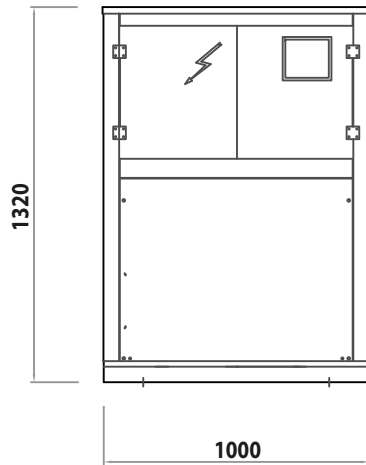

FRONT VIEW

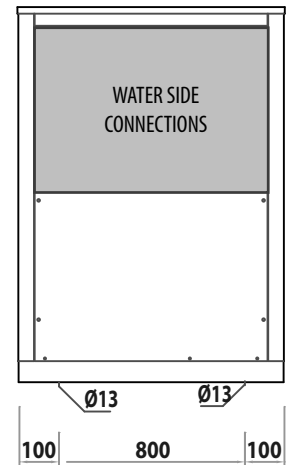

BACK VIEW

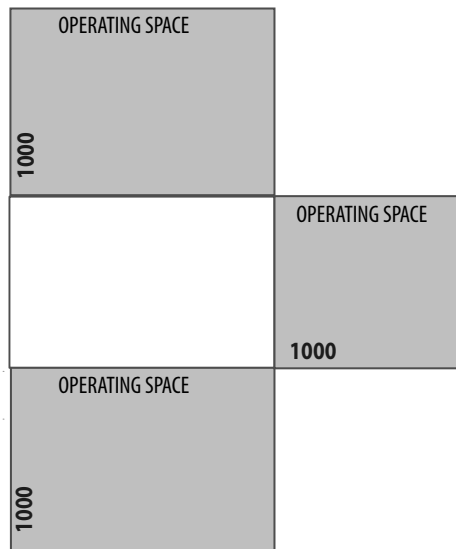

TOP VIEW

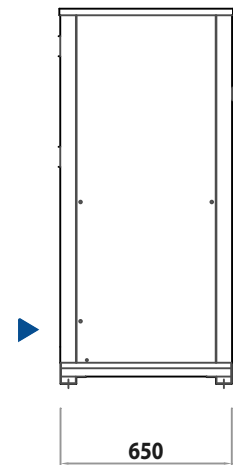

SIDE VIEW

▶ **ELECTRIC CABLES INPUT**

W_1280x990r

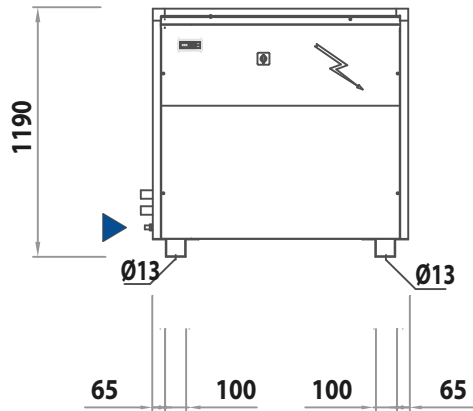

FRONT VIEW

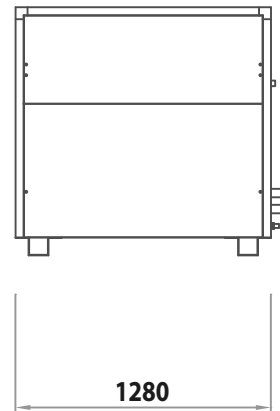

BACK VIEW

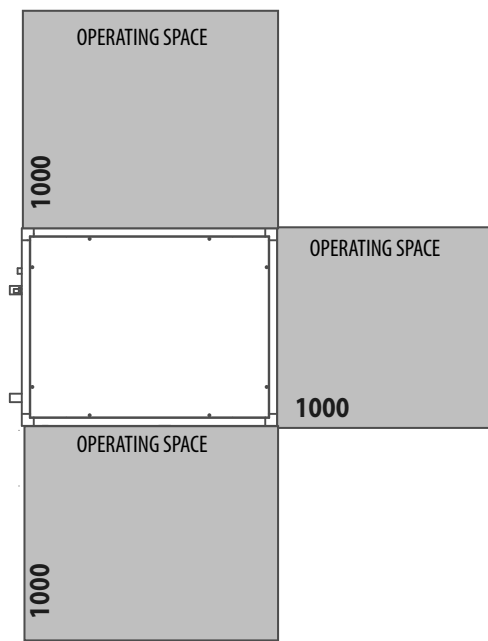

TOP VIEW

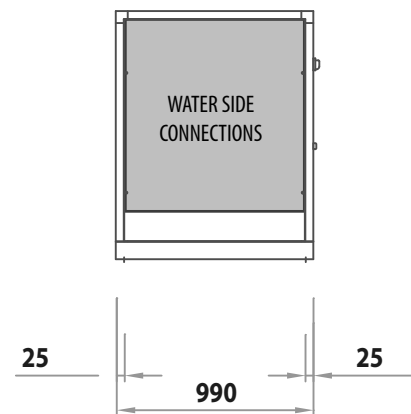

SIDE VIEW

▶ **ELECTRIC CABLES INPUT**

W_1300x650

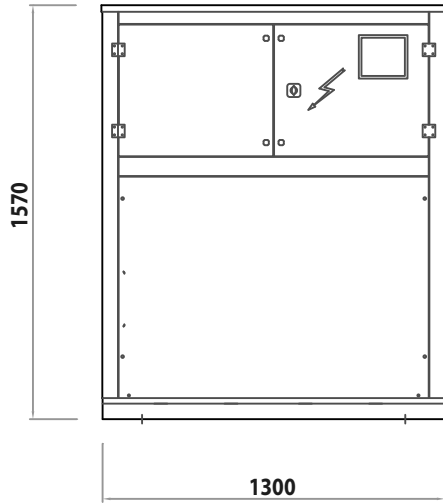

FRONT VIEW

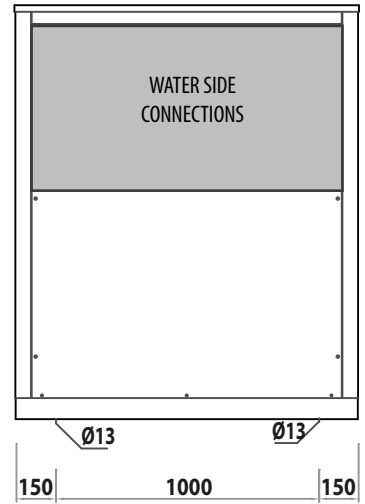

BACK VIEW

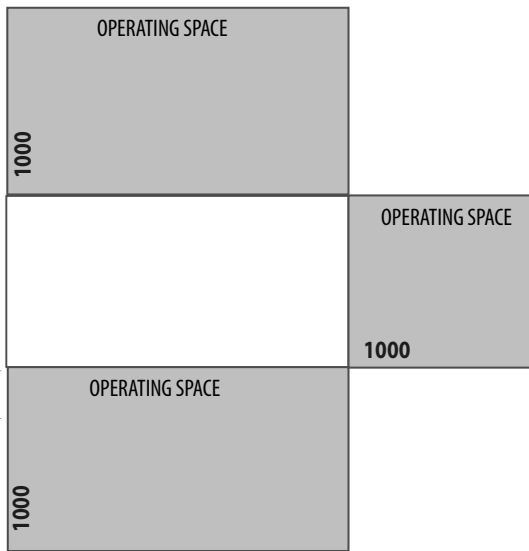

TOP VIEW

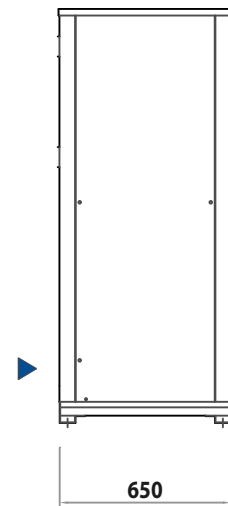

SIDE VIEW

▶ **ELECTRIC CABLES INPUT**

W_2250x820

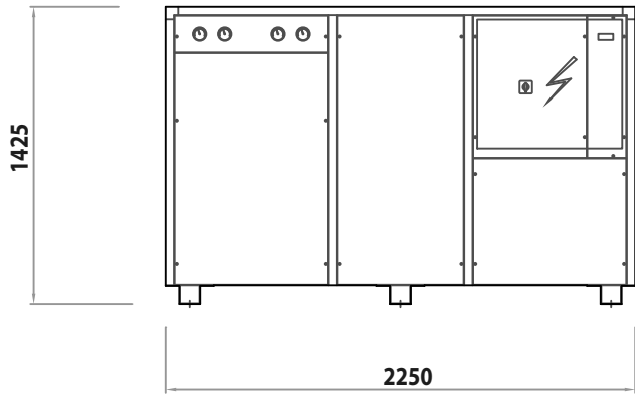

FRONT VIEW

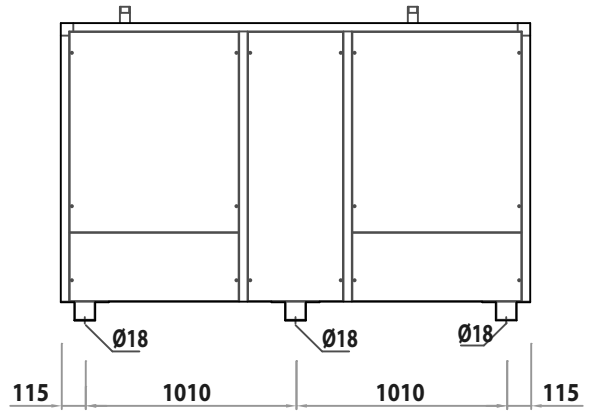

BACK VIEW

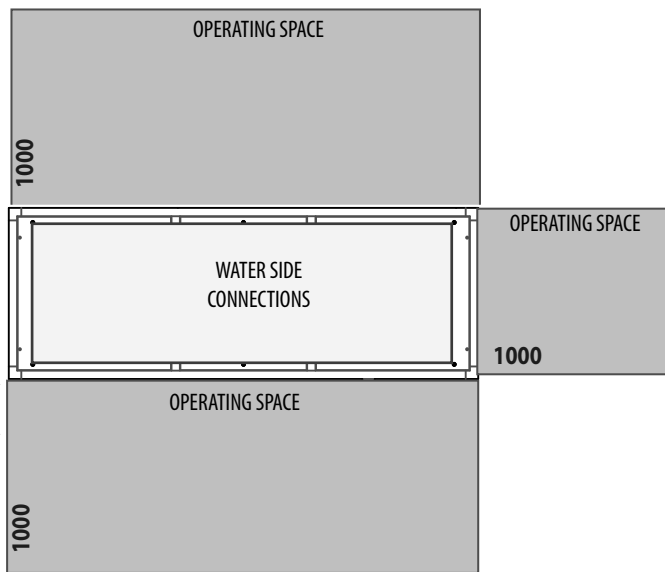

TOP VIEW

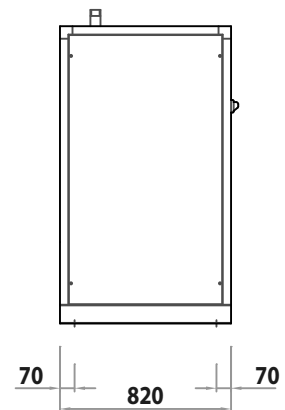

SIDE VIEW

▶ **ELECTRIC CABLES INPUT**

W_3800x1150

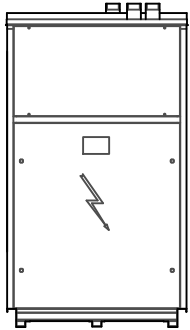

FRONT VIEW

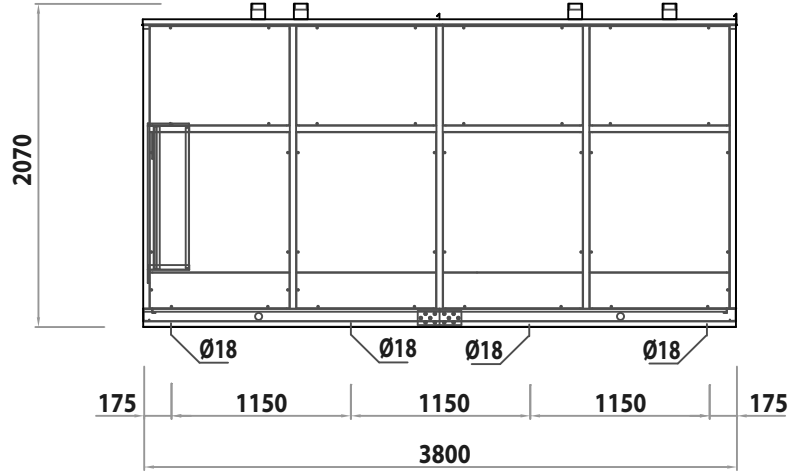

SIDE VIEW

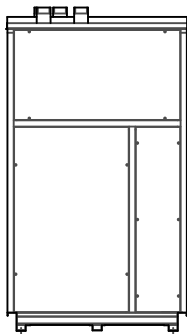

BACK VIEW

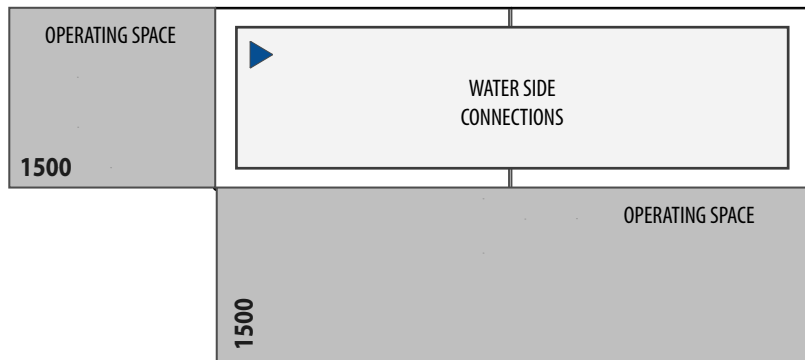

TOP VIEW

▶ **ELECTRIC CABLES INPUT**

W_2580x990

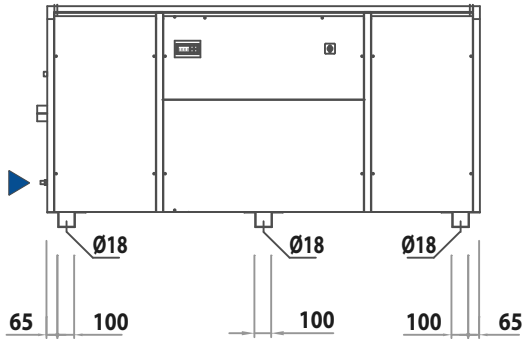

FRONT VIEW

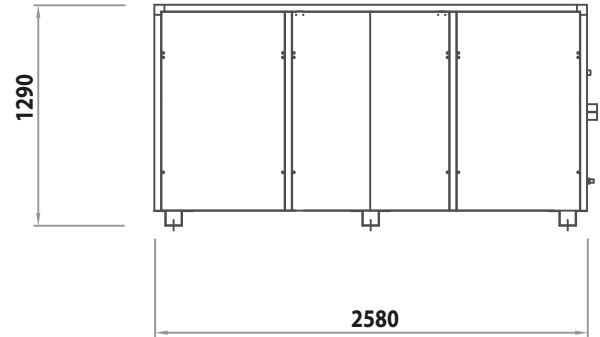

BACK VIEW

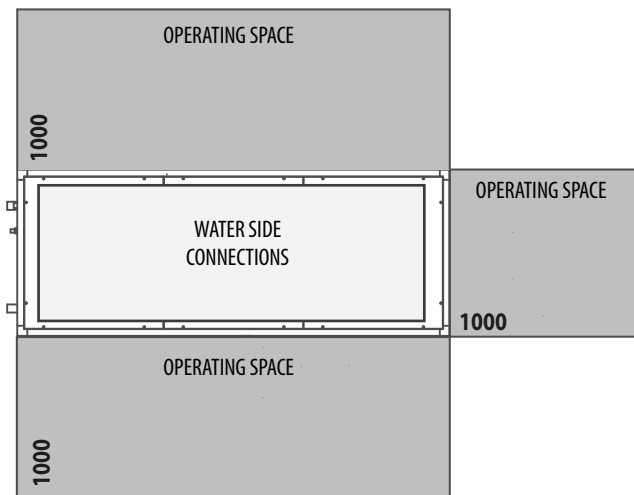

TOP VIEW

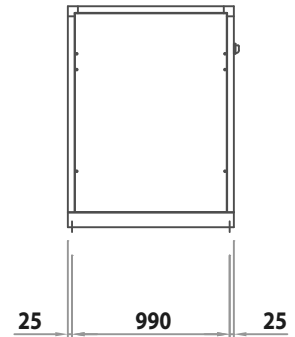

SIDE VIEW

► **ELECTRIC CABLES INPUT**

W_3520x990

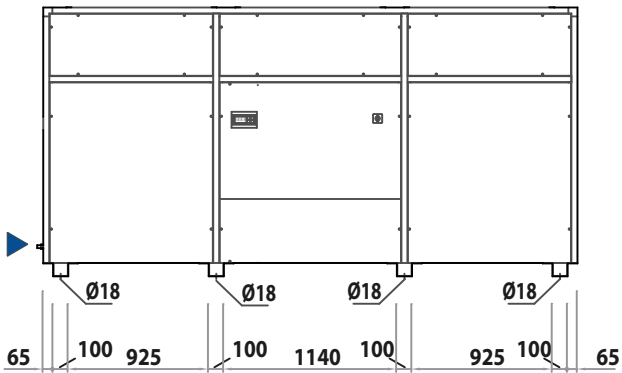

FRONT VIEW

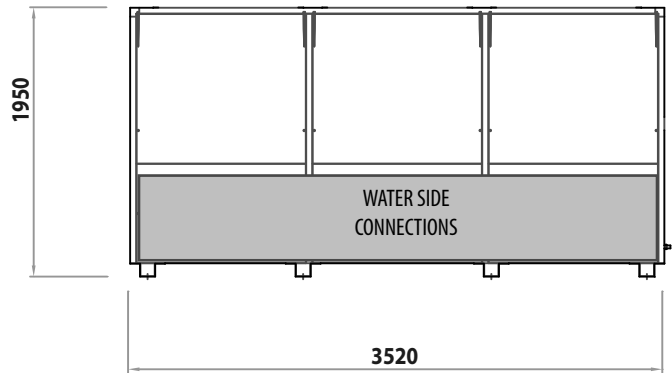

BACK VIEW

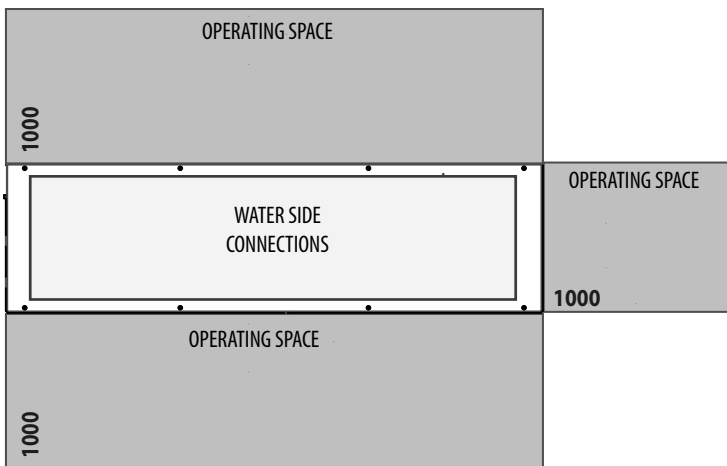

TOP VIEW

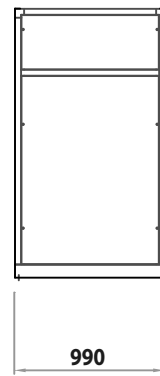

SIDE VIEW

▶ **ELECTRIC CABLES INPUT**